

Installation, Operation and Maintenance Manual

for the
MOGAS C-Series Metal-Seated Ball Valve

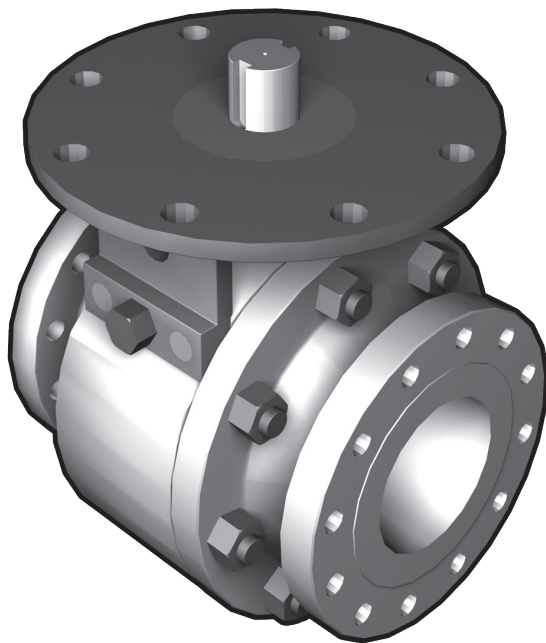

**PREPARE THE VALVE FOR
INSTALLATION**

ACTUATE THE VALVE

**INSTALL THE VALVE
PROPERLY**

**MAINTAIN THE VALVE FOR
OPTIMAL OPERATION
AND PERFORMANCE**

MOGAS[®]
SEVERE SERVICE BALL VALVES

Read Before Installing Valve

All MOGAS valves operate **counter-clockwise to open, clockwise to close**.

MOGAS valves are supplied in a variety of operator configurations based upon customer requirements, and may be operated by

- manual actuation (handlever)
- pneumatic actuation
- worm gear actuation (handwheel)
- hydraulic actuation

Each of these operator configurations may be installed and tested prior to shipping, or shipped separately, depending on customer requirements.

Some valves are supplied with a bare stem or stem adaptor kits to accommodate a variety of manual or actuated operators.

Please note the configuration of each individual valve and proceed with any necessary operator adaption procedures prior to installing the valve.

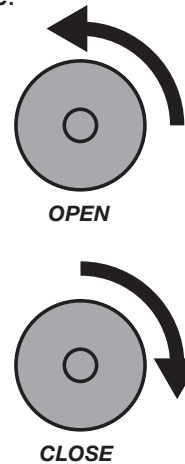

How to Read this Manual

All information within this manual is relevant to the safe and proper care of your MOGAS ball valve. Please understand the following examples of instructional information:

5 **INSTALL STEM ADAPTOR**
Align stem adaptor **13** so the keyways on stem adaptor correspond with the keys **06** on stem **05**.

Sequential procedure
required to perform operation.

Bold numbers correspond
with items shown in the **Valve Item Reference Number** sections.

▶ **PRE-INSTALLATION STORAGE**
Valves shall remain stored in their shipping crates with the lids secured.

General information or an alternate / variation procedure.

! **CAUTION!**
Ensure key length provides and maintains full engagement.

Warning statement
to prevent unwanted consequence.

THIS WILL AFFECT THE VALVE WARRANTY.

Note:
The normal direction of flow is from the higher pressure end (upstream) to lower pressure end when the valve is **closed**.

Note(s) to support procedure.

Contents

VALVE ITEM REFERENCE NUMBER	
MANUAL ADAPTION (HANDLEVER).....	4
ACTUATOR ADAPTION	6
TRANSPORT AND STORAGE.....	8
PRE-INSTALLATION	9
INSTALL OPERATOR	
MANUAL ADAPTION (HANDLEVER).....	10
ACTUATOR ADAPTION	14
INSTALLATION	18
OPERATION.....	20
MAINTENANCE.....	21
REMOVE OPERATOR	
MANUAL ADAPTION (HANDLEVER).....	24
ACTUATOR ADAPTION	24
ROTATE OPERATOR	
ACTUATOR ADAPTION	26
REPLACE STEM PACKING.....	31
DISASSEMBLY.....	36
REWORK COMPONENTS.....	43
RE-ASSEMBLY	45
LOCATE VALVE INFORMATION	58
RETURN MERCHANDISE AUTHORIZATIONS (RMA)	59
SERVICE CONTACT	59

Valve Item Reference Number

Manual Adaption (Handlelever)

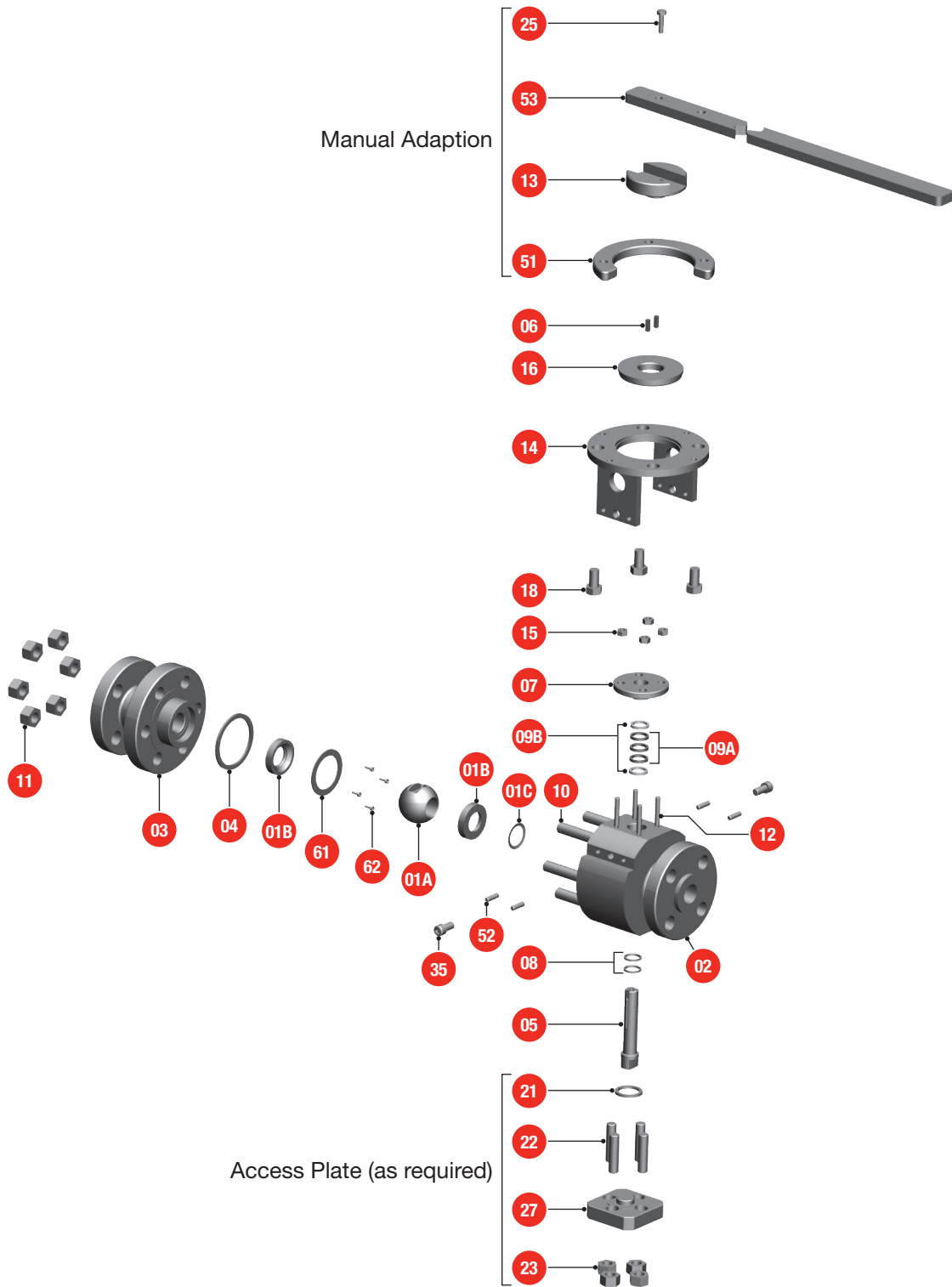

Valve Item Reference Number

Manual Adaption (Handlever)

Valve Part Reference Number	
Item	Description
01A	Ball
01B	Seat Ring
01C	Spring Disc
02	Body
03	End Connection
04	Gasket
05	Stem
06	Key
07	Gland Flange
08	Stem Seal Bearing
09A	Packing Ring
09B	Anti-Extrusion Ring
10	Body Stud
11	Body Nut
12	Gland Stud
13	Stem Adaptor
14	Mounting Flange
15	Gland Nut
16	Flange Bushing
18	Hex Head Screw
21	Gasket (as required)
22	Stud (as required)
23	Nut (as required)
25	Hex Head Screw
27	Access Plate (as required)
35	Screw
51	Mounting Flange Adaptor
52	Pin
53	Handlever
61	Seat Locking Ring
62	Seat Locking Screws (as required)

Valve Item Reference Number

Actuator Adaption

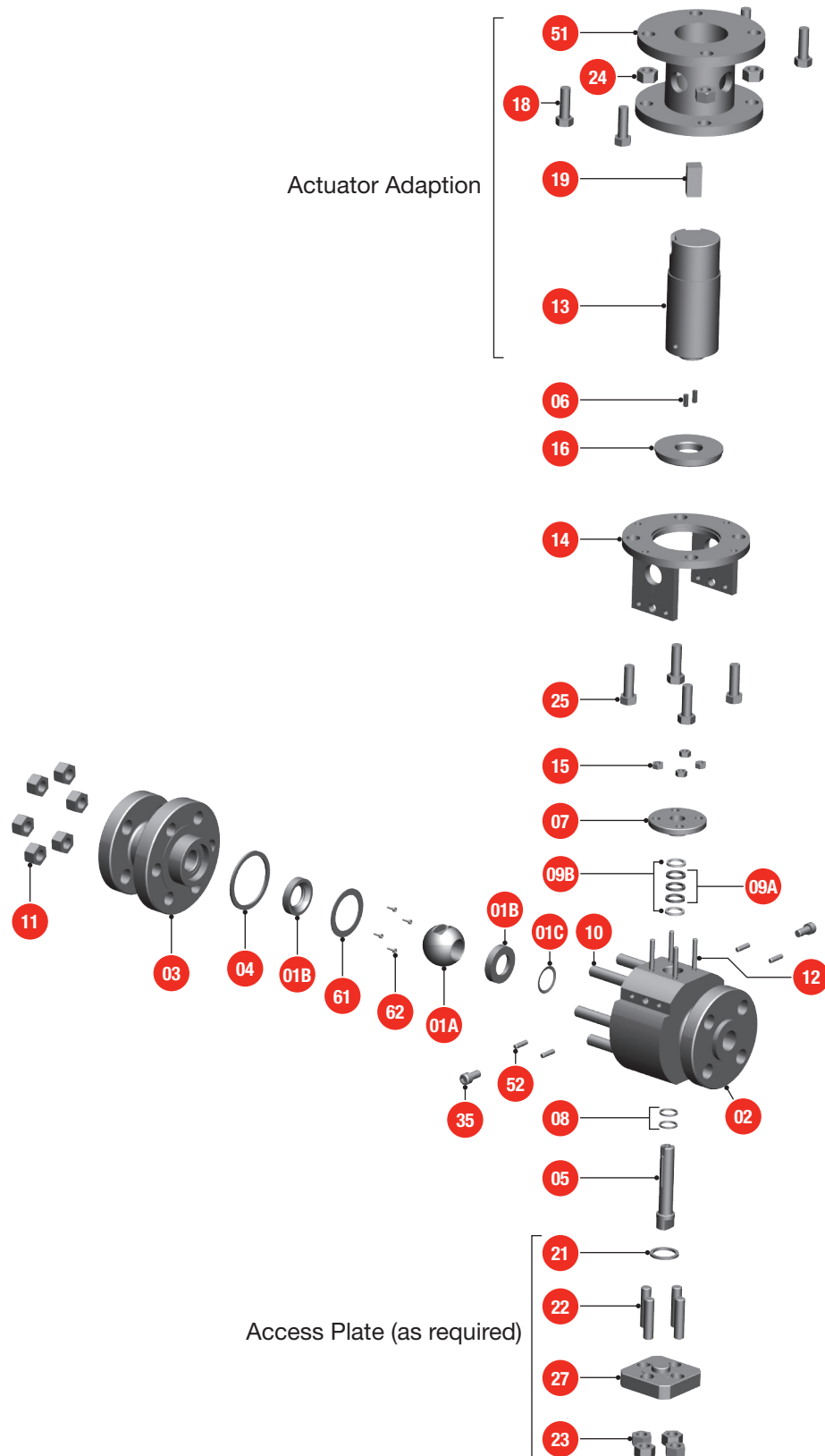

Valve Item Reference Number

Actuator Adaption

Valve Part Reference Number	
Item	Description
01A	Ball
01B	Seat Ring
01C	Spring Disc
02	Body
03	End Connection
04	Gasket
05	Stem
06	Key
07	Gland Flange
08	Stem Seal Bearing
09A	Packing Ring
09B	Anti-Extrusion Ring
10	Body Stud
11	Body Nut
12	Gland Stud
13	Stem Adaptor (optional)
14	Mounting Flange
15	Gland Nut
16	Flange Bushing
18	Hex Head Screw
19	Key (optional)
21	Gasket (as required)
22	Stud (as required)
23	Nut (as required)
24	Nut (optional)
25	Hex Head Screw
27	Access Plate (as required)
35	Socket Head Screw
51	Mounting Flange Adaptor (optional)
52	Pin
61	Seat Locking Ring
62	Seat Locking Screws (as required)

Transport and Storage

These procedures outline the general requirements for storage of MOGAS valves.

▶ **TRANSPORT**

Valves will be shipped in seaworthy export packed wooden crates that are plastic lined.

Upon arrival at the site, inspect the general condition of the valve (and actuator, if supplied) for any potential shipping damage.

▶ **PRE-INSTALLATION STORAGE**

Valves shall remain stored in their shipping crates, or on their pallets, with the lids secured.

Valves are shipped with corrosion-resistant paint and desiccant dries (dryer bags) for storage up to six months.

For long-term storage, the internal parts of carbon and alloy steel valves should be sprayed with a rust preventative.

All protective covers and plastic liners should remain in place.

▶ **REMOVING VALVE FROM SERVICE**

Before the valve is removed from the line, it should be placed in the **open** position to prevent further internal damage to valve components.

The valve should be placed in a vertical position, or raised at an angle. The bore of the valve should be either steamed cleaned or power washed to remove slurry and debris.

The valve should be allowed to drain and dry. A petroleum-based rust inhibitor should be applied through the bore of the valve immediately after the valve is dry.

Flange protectors need to be secured to each end of the valve to prevent any foreign debris from entering the valve. It is recommended to place desiccant dryer bags inside the valve before storage.

The valve should be stored in the vertical position, out of the weather (inside), until repairs can be made.

Pre-Installation

1 REMOVE VALVE

Remove the valve (and actuator, if supplied) carefully from the shipping crate or pallet using lifting lugs or nylon straps around the **valve body** and sturdy section of the actuator. **Do not** lift by the actuator alone.

2 INSPECT VALVE

Inspect the general condition of the valve (and actuator, if supplied) for any potential shipping damage.

Review the valve manual, assembly drawing with the bill of materials, and the actuator manual (if supplied) shipped with the valve.

3 REMOVE PROTECTIVE COVERS

Remove protective covers from the valve ends.

Inspect internally for shipping debris or damage.

4 INSTALL OPERATOR

If the valve was ordered with a handlever or actuator from MOGAS, it should arrive pre-assembled and tested from the factory. If already assembled, proceed to **Installation** (page 18) and continue with the valve installation.

If the valve **does not** have a handlever or actuator installed, you **must** install the appropriate adaptor and handlever / actuator to open and close the valve prior to valve installation. Proceed to **Install Operator – Manual Adaption (Handlever)** (page 10) or **Install Operator – Actuator Adaption** (page 14).

Install Operator

Manual Adaption (Handlever)

These procedures apply only to manual adaption (handlever) supplied by MOGAS or a MOGAS authorized distributor.

Note:

Valve item numbers shown in **bold** correspond with items shown in the **Valve Item Reference Number, Manual Adaption** section (pages 4 and 5) of this document.



CAUTION!

It is **extremely important** to follow these steps to ensure maximum valve performance.

THIS WILL AFFECT THE VALVE WARRANTY.

1 VALVE ORIENTATION

Secure the valve in a horizontal position.

The bore should be horizontal, with the stem in a vertical position.

The mounting flange should be level.

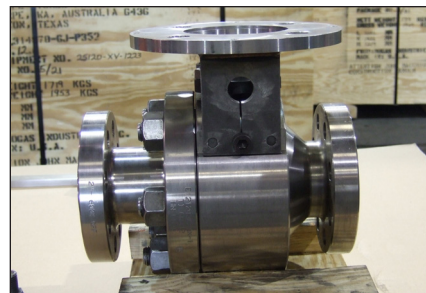

2 STEM ORIENTATION

Verify that the keyway nearest the stamped **T** on the end of the valve stem **05** is oriented properly ('T' to the top).

When the valve is **closed**, the keyway nearest the stamped **T** should face the end connection **03**, or bolting side of valve.

When the valve is **open**, the keyway nearest the stamped **T** should face 90° counter-clockwise from the end connection **03**, or bolting side of the valve.



3 INSTALL FLANGE BUSHING

Insert flange bushing **16**.

If necessary, tap into place using a hammer and a brass or aluminum rod or wooden block.

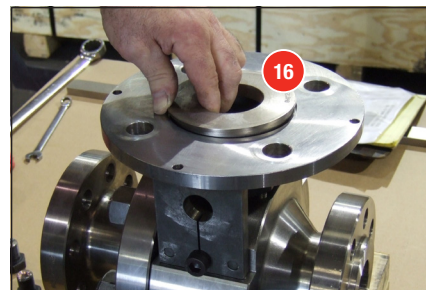

Install Operator

Manual Adaption (Handlever)

4 INSERT KEYS

Insert keys **06** into stem keyways.



CAUTION!

Ensure key length provides and maintains full engagement.

THIS WILL AFFECT THE VALVE WARRANTY.

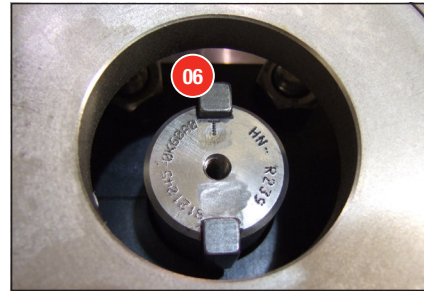

5 INSTALL STEM ADAPTOR

Align stem adaptor **13** so the keyways on stem adaptor correspond with the keys **06** on stem **05**.

Verify that the ball **01A** open / closed position matches the handlever **53** open / closed position.

Note:

The MOGAS valve operates *counter-clockwise to open, clockwise to close*.

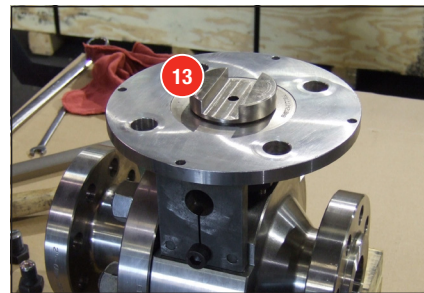

Verify that the scribed lines on the stem **05** and stem adaptor **13** align with the scribed lines on the gland flange **07**. These lines are approximate indications and are not 100% accurate. For best results, make sure the lines never under travel — a minimum travel of 96° is required.

Slide stem adaptor **13** onto stem **05**.

Note:

It may be necessary to tap stem adaptor into position with a side-to-side motion.



CAUTION!

Do not force stem adaptor onto stem. Proper alignment is critical to ensure the stem adaptor slides into position.

If stem adaptor is forced onto stem, severe damage could occur.

THIS WILL AFFECT THE VALVE WARRANTY.

Install Operator

Manual Adaption (Handlever)

6 INSTALL MOUNTING FLANGE ADAPTOR

Verify that the handlever **53** recess in the stem adaptor **13** is oriented 90° to the bore in **closed** position.

Position mounting flange adaptor **51** onto mounting flange. The open quadrant of the mounting flange adaptor **51** must allow the handlever **53** to travel counter-clockwise to an inline position with the bore.

Insert hex head bolts **18** from underside and tighten temporarily to allow repositioning of the mounting flange adaptor when setting the stop positions.

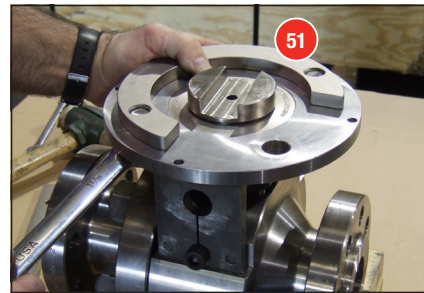

7 INSTALL HANDLEVER

Install handlever **53** into recess of stem adaptor **13**, aligning the mounting hole as required.

The handlever **53** should be positioned 90° to bore for **closed**, and inline with bore for **open**.

Install hex head bolt **25** through handlever **53** into top of stem **05**. Tighten as required.

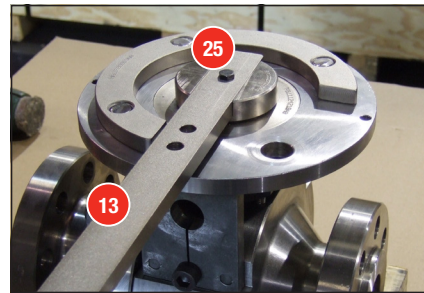

Note:

Some installations may require a washer between hex head screw and handlever.

Note:

*Holes are provided in the handlever and mounting flange to allow locking the handlever **open** / **closed** position per customer specifications.*

Install Operator

Manual Adaption (Handlever)

8 VERIFY OPERATION

Note:

The MOGAS valve operates **counter-clockwise to open, clockwise to close**.

Using the handlever **53**, the valve should be stroked to ensure that the ball **01A** is rotating properly, and the ball position matches the **open / closed** position of the handlever **53**.

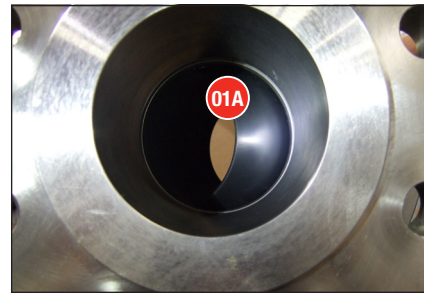

Stroke the ball to ensure proper rotation.

9 SET STOP POSITIONS

To adjust stop positions, loosen hex head screws **18** and carefully reposition the mounting flange adaptor **51** as required.

The **fully open** position is the most important position to set. It is preferred that the **open** position be set **before** the valve is installed in the pipeline.

The **fully open** position should properly align the bore, ensuring that no edges of the ball **01A** are exposed to the flow.



Fully OPEN position.

For visual verification of **open / closed**, locate the **scribed lines** on the stem adaptor **13**, stem **05** and gland flange **07**. These lines are approximate locations and should not be used for setting the **open** stop. For best results, ensure the lines never under travel — a minimum travel of 96° is required.

When the **open / closed** position is properly set, the scribed lines on the stem adaptor, stem and gland flange should match.

Fully tighten hex head screws **18** to secure the mounting flange adaptor **51** in place.



CAUTION!

Misalignment can result in valve under- or over-stroke, creating a potential leak path.

THIS WILL AFFECT THE VALVE WARRANTY.

Install Operator

Actuator Adaption

These procedures apply to hydraulic, pneumatic and worm gear actuation supplied by MOGAS or a MOGAS authorized distributor. Otherwise, refer to the actuator manufacturer's manual for specific operator / actuator removal procedures.

Note:

Valve item numbers shown in **bold** correspond with items shown in the **Valve Item Reference Number, Actuator Adaption** section (pages 6 and 7) of this document.



CAUTION!

It is **extremely important** to follow these steps to ensure maximum valve performance.

THIS WILL AFFECT THE VALVE WARRANTY.

1 VALVE ORIENTATION

Secure the valve in a horizontal position.

The bore should be horizontal, with the stem in a vertical position.

The mounting flange should be level.



2 STEM ORIENTATION

Verify that the keyway nearest the stamped **T** on the end of the valve stem **05** is oriented properly ('T' to the top).

When the valve is **closed**, the keyway nearest the stamped **T** should face the end connection **03**, or bolting side of valve.

When the valve is **open**, the keyway nearest the stamped **T** should face 90° counter-clockwise from the end connection **03**, or bolting side of the valve.

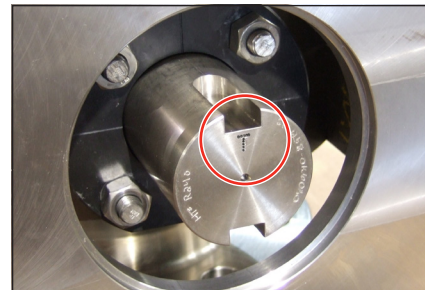

3 INSERT KEYS

Insert keys **06** into stem keyways.

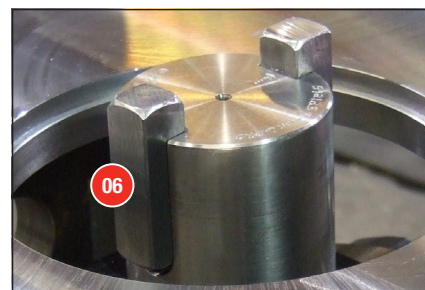

Install Operator

Actuator Adaption



CAUTION!

Ensure key **19** length provides and maintains full engagement.

Supplier of adaption package should provide key **19** specifications.

THIS WILL AFFECT THE VALVE WARRANTY.

4 INSTALL FLANGE BUSHING

If not already present, insert the flange bushing **16**.

If necessary, tap into place using a hammer and a brass or aluminum rod or wooden block.



5 OPERATING POSITION

Verify that the valve and actuator are in the same operating position (**open** or **closed**).

6 STEM ADAPTOR

Note:

Some installations may not require a stem adaptor.

Align the stem adaptor **13** so the keyway on the stem adaptor corresponds with the keyway on the actuator.

Slide stem adaptor **13** onto stem **05**.



7 MOUNTING FLANGE ADAPTOR

Note:

Some installations may not require mounting flange adaptor.

If mounting flange adaptor **51** is required, attach to valve mounting flange using hex head screws **25** and nuts **24**.

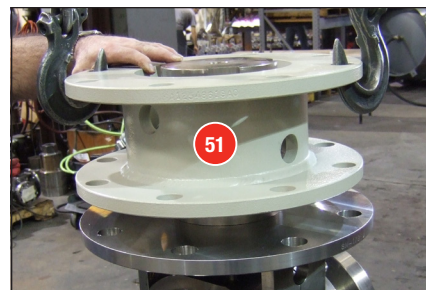

CAUTION!

Torque the bolting per the specifications included with the **test certificate** for each individual valve serial number.

THIS WILL AFFECT THE VALVE WARRANTY.

Install Operator

Actuator Adaption

8 INSTALL KEY

Insert key **19** into stem adaptor keyway.

Note:

Some installations may require inserting the key through an access port in the actuator, after actuator is in position.



CAUTION!

Ensure key **19** length provides and maintains full engagement.

Supplier of adaption package should provide key **19** specifications.

THIS WILL AFFECT THE VALVE WARRANTY.

9 MOUNT ACTUATOR

Align key **19** of stem adaptor **13** with keyway of actuator.

Carefully place the actuator on the valve mounting flange **14** (or adaptor **51**).



CAUTION!

Do not force actuator onto stem adaptor. Proper alignment is critical to ensure the actuator slides gently into position.

If stem is forced into valve, severe damage could occur.

THIS WILL AFFECT THE VALVE WARRANTY.



10 INSTALL BOLTS

Install the hex head screws **18**, and torque as required.



CAUTION!

If the actuator is supplied by MOGAS, refer to the torque values in the **test certificate** provided for each individual valve serial number.

Otherwise, refer to the manufacturer's specifications.

THIS WILL AFFECT THE VALVE WARRANTY.



Install Operator

Actuator Adaption

11 VERIFY OPERATION

Note:

The MOGAS valve operates **counter-clockwise to open, clockwise to close**.

The actuator should be stroked to ensure that the ball **01A** is rotating properly, and the ball position matches the **open / closed** indicators on the actuator.

If the ball requires alignment, the actuator stops should be reset at this time, per the manufacturer's specifications.

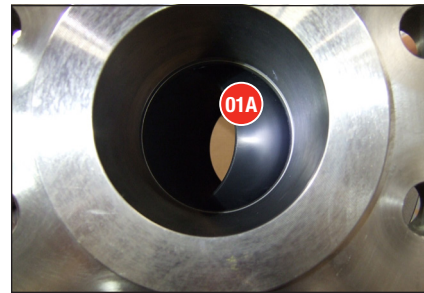

Stroke the ball to ensure proper rotation.

12 SET STOP POSITIONS

Note:

The actuator stops may be reset per the manufacturer's specifications to achieve **fully open** and / or **fully closed** position.

The **fully open** position is the most important position to set. It is preferred that the **open** position be set **before** the valve is installed in the pipeline.

The **fully open** position should properly align the bore, ensuring that no edges of the ball **01A** are exposed to the flow.

For visual verification of **open / closed**, locate the **scribed lines** on the stem **05** and gland flange **07**. These lines are approximate locations and should not be used for setting the **open** stop. For best results, ensure the lines never under travel — a minimum travel of 96° is required.

When the actuator is properly set, the scribed lines on the stem and gland flange should match.



Fully OPEN position.

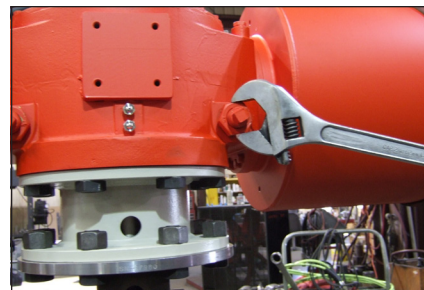

Set stop positions.



CAUTION!

Misalignment can result in valve under- or over-stroke, creating a potential leak path.

THIS WILL AFFECT THE VALVE WARRANTY.

Installation

Note:

Valve item numbers shown in **bold** correspond with items shown in the **Valve Item Reference Number** section (pages 4 – 7) of this document.

1 VERIFY OPERATING POSITION

Note:

The MOGAS valve operates **counter-clockwise to open, clockwise to close**.

While looking in the bore, **open** and **close** the valve.

Note:

Larger valves may require the actuator to be in place to rotate the ball.

Verify that the ball **open** / **closed** position matches the handlever or actuator **open** / **closed** position indicators.

Verify that the scribed lines on the stem **05** align with the scribed lines on the gland flange **07**. These lines are approximate indications. For best results, make sure the lines never under travel — a minimum travel of 96° is required.

Note:

Misalignment can result in valve under- or over-stroke, creating a potential leak path and affecting warranty.

The **fully open** position is the most important position to set. It is preferred that the **open** position be set while the valve is not installed in the pipeline. This allows for the bore to be properly aligned, ensuring that no edges are exposed to the flow.



Fully OPEN position.

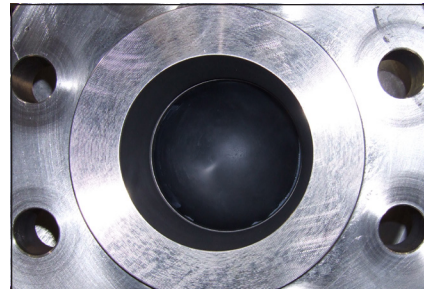

Fully CLOSED position.



CAUTION!

The actuator must not be re-oriented without removal from the valve. This prevents 180° rotation of the ball and assures the mate-lapped ball and seat surfaces match. (Seat leakage may occur when the ball and seat surfaces are not matched per the engineered design.)

Refer to **Rotate Operator – Actuator Adaption** (page 26) for proper procedures to rotate the actuator.

THIS WILL AFFECT THE VALVE WARRANTY.

Installation



CAUTION!

All welding / grinding debris must be thoroughly flushed from all associated piping before valve is installed.

THIS WILL AFFECT THE VALVE WARRANTY.

2 IDENTIFY SEALING DIRECTION

Identify the preferred sealing direction of the valve, indicated by **Pressure End** stamped on the valve body **02**.

Note:

The normal direction of flow is from the higher pressure end (upstream) to lower pressure end when the valve is **closed**.

In certain conditions, proper operation may require the indicated flow be opposed to the line flow. Make sure that the **Pressure End** is positioned toward the highest pressure against the valve in the **closed** position.



3 POSITION VALVE IN PIPING

Verify that the valve and actuator / handlever orientation is correct.

Verify that the valve is in the **open** position to prevent any damage to the ball surface from debris.

Position the valve in line with mating flanges.

Note:

Support or lift as required, using lifting lugs or nylon straps around the valve body. Do not lift or support by the actuator alone.

4 SECURE VALVE IN PLACE

Install flange gaskets and bolting per customer requirements.

Note:

MOGAS valve flanges are supplied in the customary "straddle centerline" hole orientation, unless otherwise specified.

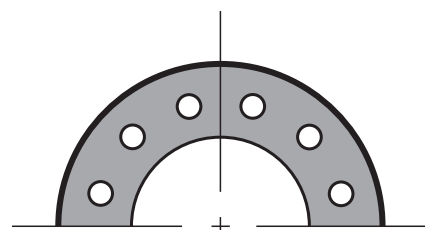

Straddle centerline hole orientation

These procedures are for raised-face flange connections. When securing other end types, please contact MOGAS Service for proper procedures.

5 VERIFY OPERATION

After installation, **open** and **close** several times to ensure smooth operation.

Operation

▶ OPEN / CLOSE

All MOGAS ball valves are designed for on / off services only.

To operate, turn **counter-clockwise to open** and **clockwise to close**.

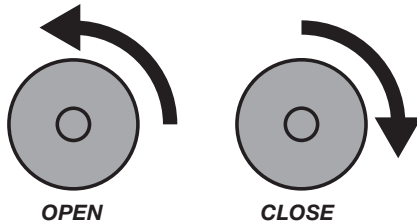

Note:

When cycling the valve **open** or **close**, make sure that the valve is **fully opened** and **fully closed**. This wipes debris from the ball and ensures optimal performance and long valve life.



CAUTION!

Throttling with ball valves is **NOT** recommended. Prolonged exposure of a portion of the ball to flow can compromise the sealing integrity of the valve.

THIS WILL AFFECT THE VALVE WARRANTY.



Fully OPEN position.

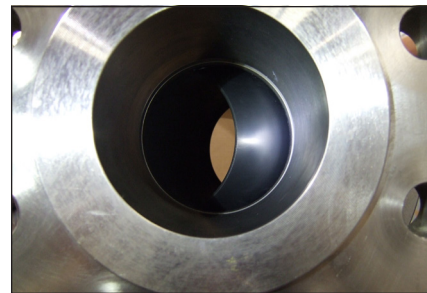

*Partially OPEN position
(not recommended).*

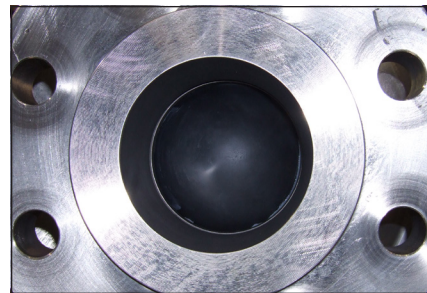

Fully CLOSED position.

Maintenance



CAUTION!

It is **extremely important** to follow these steps to ensure maximum valve performance.

THIS WILL AFFECT THE VALVE WARRANTY.



VERIFY BOLTING TORQUE

After the first exposure to elevated temperature and the valve has completely cooled-down, verify bolting torque at these locations:

- 1 Packing gland flange
- 2 Body to end connection
- 3 Access plate (if present)
- 4 Actuator to valve mounting (if present)

Check the bolting at these same locations periodically.

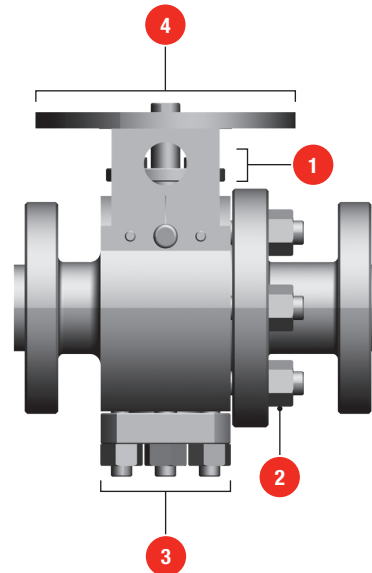

CAUTION!

If bolting torque is lower than specified values on the **test certificate** provided for each **individual** valve serial number, re-torque bolting as necessary.

THIS WILL AFFECT THE VALVE WARRANTY.



OPEN / CLOSE VALVE REGULARLY

Valves remaining **open** or **closed** for a long period of time should be cycled **open / closed** at least once a year.

Valves should always be **fully opened** and **fully closed** to wipe away any accumulation on the sealing surfaces.



ACTUATOR LUBRICATION

Keep hydraulic, pneumatic and worm gear actuators fully lubricated according to actuator manufacturer's specifications.

Remove Operator

Manual Adaption (Handlever)

These procedures apply only to manual adaption (handlever) supplied by MOGAS or a MOGAS authorized distributor.

Note:

Valve item numbers shown in **bold** correspond with items shown in the **Valve Item Reference Number, Manual Adaption** section (pages 4 and 5) of this document.



CAUTION!

It is **extremely important** to follow these steps to ensure maximum valve performance.

MOGAS does not recommend removing the operator while valve is subject to operating conditions.

THIS WILL AFFECT THE VALVE WARRANTY.

1

REMOVE HANDLEVER

Remove hex head screw **25** holding handlever **53** in place.

Note:

Some installations may require removal of washer.

Remove handlever **53**.

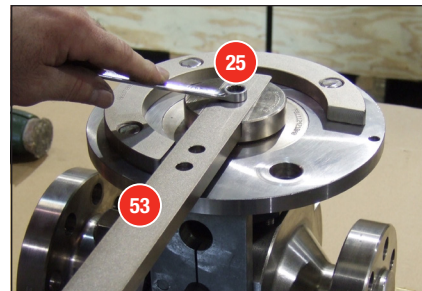

STOP POSITIONS

In most cases, it is recommended to leave the mounting flange adaptor **51** in place to maintain accurate **open / closed** stop positions.

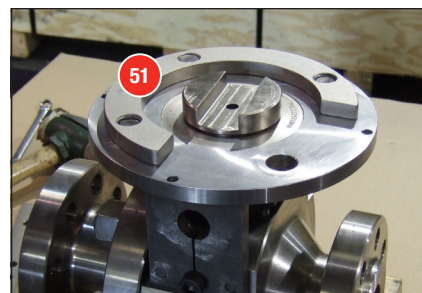

Remove Operator

Manual Adaption (Handlever)

2 REMOVE STEM ADAPTOR

Remove stem adaptor **13** by lifting or prying upward as required.

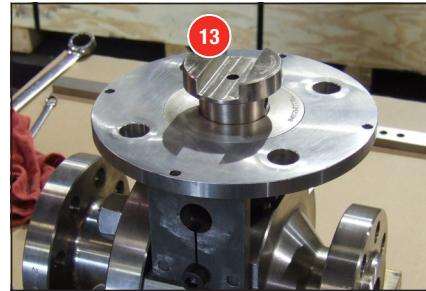

3 REMOVE FLANGE BUSHING

Remove the flange bushing **16** by driving it upwards and off the mounting flange **14**, using a hammer and brass or aluminum rod if necessary.

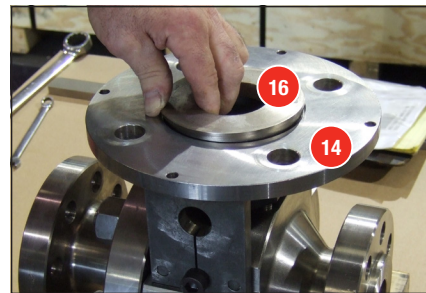

4 REMOVE KEYS

Remove keys **06** from stem **05** keyways.

Remove Operator

Actuator Adaption

These procedures apply to hydraulic, pneumatic and worm gear actuation supplied by MOGAS or a MOGAS authorized distributor. Otherwise, refer to the actuator manufacturer's manual for specific operator / actuator removal procedures.

Note:

Valve item numbers shown in **bold** correspond with items shown in the **Valve Item Reference Number, Actuator Adaption** section (pages 6 and 7) of this document.



CAUTION!

It is **extremely important** to follow these steps to ensure maximum valve performance.

MOGAS does not recommend removing the operator while valve is subject to operating conditions.

THIS WILL AFFECT THE VALVE WARRANTY.

1

REMOVE BOLTING

Remove hex head screws **18** holding actuator to mounting flange (or mounting flange adaptor **51**, if provided).

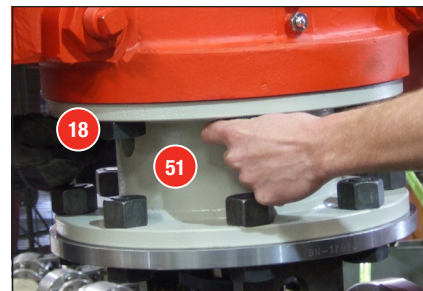

2

LIFT ACTUATOR

Lift the actuator straight up and off the mounting flange **14** (or mounting flange adaptor **51**).



CAUTION!

The actuator must not be re-oriented without removal from the valve. This prevents 180° rotation of the ball and assures the mate-lapped ball and seat surfaces match. (See page 53, step 16 for matching clarification.) Seat leakage may occur when the ball and seat surfaces are not matched.)

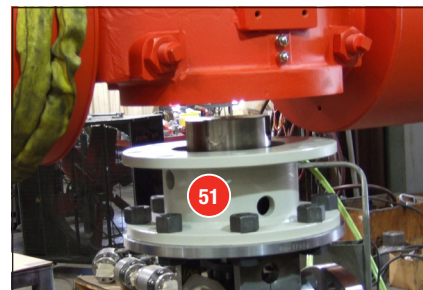

THIS WILL AFFECT THE VALVE WARRANTY.

Remove Operator

Actuator Adaption

3 REMOVE MOUNTING FLANGE ADAPTOR

If mounting flange adaptor **51** is present, it must be removed.

Remove nuts **24** and hex head screws **25** holding the mounting flange adaptor **51** to the mounting flange **14**.

Lift the mounting flange adaptor **51** straight up and off the mounting flange **14**.

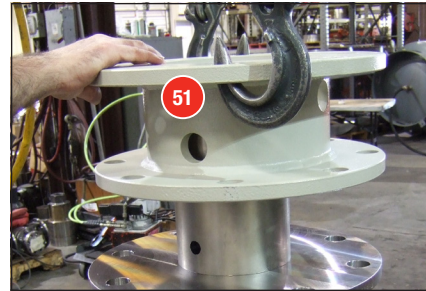

4 REMOVE STEM ADAPTOR

Remove stem adaptor **13** (if present) by lifting straight up and off the stem **05**, taking care to remove keys **06** as well.

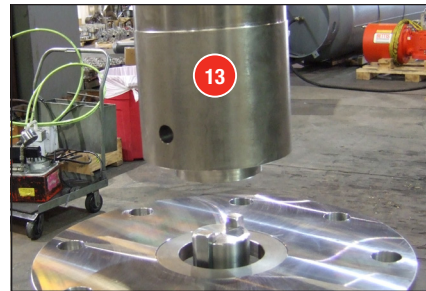

Rotate Operator

Actuator Adaption

These procedures apply to hydraulic, pneumatic and worm gear actuation supplied by MOGAS or a MOGAS authorized distributor. Otherwise, refer to the actuator manufacturer's manual for specific operator / actuator removal procedures.

Note:

Valve item numbers shown in **bold** correspond with items shown in the **Valve Item Reference Number, Actuator Adaption** section (pages 6 and 7) of this document.



CAUTION!

It is **extremely important** to follow these steps to ensure maximum valve performance.

THIS WILL AFFECT THE VALVE WARRANTY.

1

REMOVE BOLTING

Remove bolts **18** holding actuator to mounting flange (or mounting flange adapter **51**, if provided).

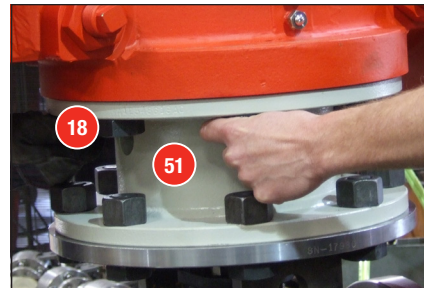

2

LIFT ACTUATOR

Lift the actuator straight up and off the mounting flange **14** (or mounting flange adaptor **51**).

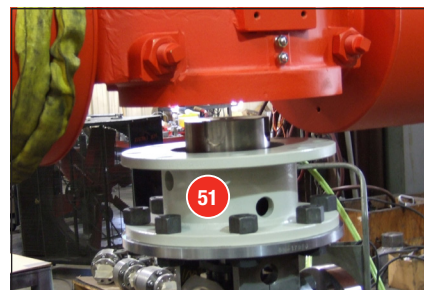

CAUTION!

The actuator must not be re-oriented without removal from the valve. This prevents 180° rotation of the ball and assures the mate-lapped ball and seat surfaces match. (See page 53, step 16 for matching clarification.) Seat leakage may occur when the ball and seat surfaces are not matched per the engineered design).

THIS WILL AFFECT THE VALVE WARRANTY.

Rotate Operator

Actuator Adaption

3 ROTATE ACTUATOR

After the actuator is removed, rotate the actuator to the desired position.

Note:

As a standard practice, MOGAS adaption is designed to be rotated in 90° increments.



4 STEM ADAPTOR POSITION

Verify the position of the stem adaptor **13**, if present.

If the slot or keyway does not match the slot or keyway in the actuator, the stem adaptor **13** must be rotated as well.

Note:

Rotating the stem adaptor may require removal of the mounting flange adaptor, if present.

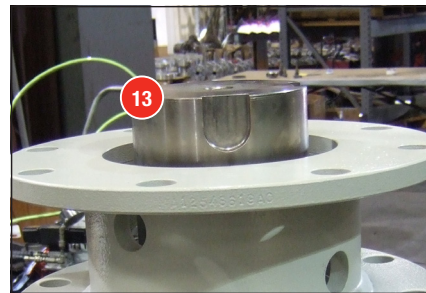

▶ REMOVE MOUNTING FLANGE ADAPTOR

If mounting flange adaptor **51** is present, it must be removed.

Remove nuts **24** and hex head screws **25** holding the mounting flange adaptor **51** to the valve mounting flange **14**.

Lift the mounting flange adaptor **51** straight up and off the valve mounting flange **14**.

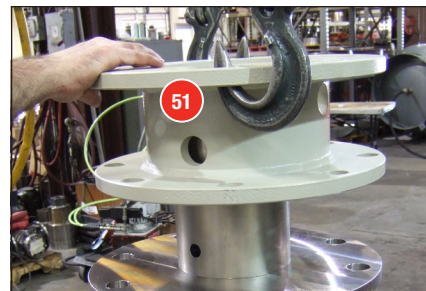

▶ REMOVE STEM ADAPTOR

Remove stem adaptor **13** (if present) by lifting straight up and off the stem **05**, taking care to remove keys **06** if necessary.

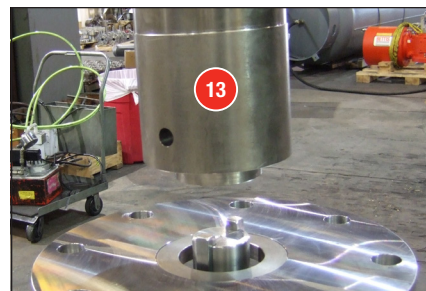

Rotate Operator

Actuator Adaption

▶ STEM ORIENTATION

Verify that the keyway nearest the stamped **T** on the end of the valve stem **05** is oriented properly ('T' to the top).

When the valve is **closed**, the keyway nearest the stamped **T** should face the end connection **03**, or bolting side of valve.

When the valve is **open**, the keyway nearest the stamped **T** should face 90° counter-clockwise from the end connection **03**, or bolting side of the valve.

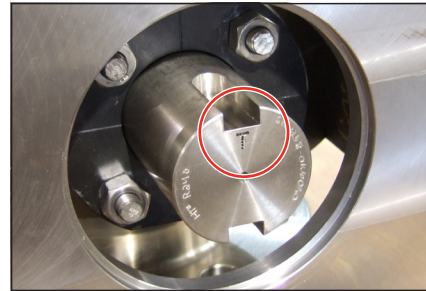

▶ ROTATE STEM ADAPTOR

Rotate the stem adaptor **13** to the position that matches the corresponding slot or keyways in the actuator.

If necessary, insert the keys **06** into keyway and slide stem adaptor **13** onto stem **05**.

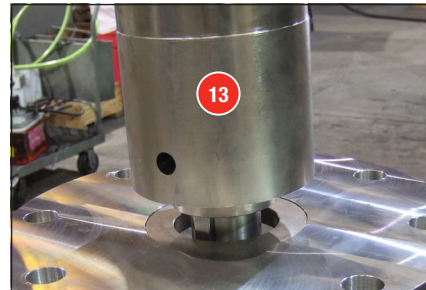

▶ MOUNTING FLANGE ADAPTOR

If mounting flange adaptor **51** is required, attach to valve mounting flange using hex head screws **25** and nuts **24**.

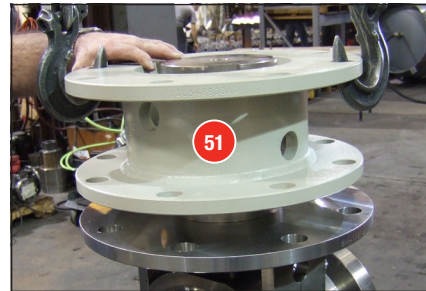

CAUTION!

Torque the mounting bolts per the specifications included with the **test certificate** for each individual valve serial number.

THIS WILL AFFECT THE VALVE WARRANTY.

Rotate Operator

Actuator Adaption

5 INSTALL KEY

Insert key **19** into stem adaptor **13** keyway.

Note:

Some installations may require inserting the key through an access port in the actuator after actuator is in position.



CAUTION!

Ensure key **19** length provides and maintains full engagement.

Supplier of adaption package should provide key **19** specifications.

THIS WILL AFFECT THE VALVE WARRANTY.

6 MOUNT ACTUATOR

Align key **19** of stem adaptor **13** with keyway of actuator.

Carefully place the actuator on the valve mounting flange **14** (or mounting flange adaptor **51**).



CAUTION!

Do not force actuator onto stem adaptor. Proper alignment is critical to ensure the actuator slides gently into position.

If stem is forced into valve, severe damage could occur.

THIS WILL AFFECT THE VALVE WARRANTY.

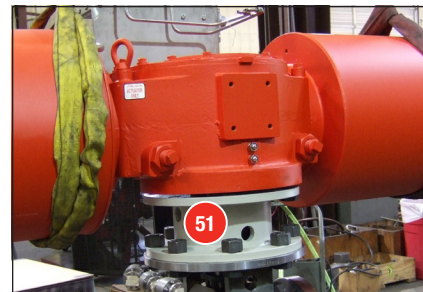

7 INSTALL BOLTS

Install the actuator bolts **18**, and torque as required.



CAUTION!

If the actuator is supplied by MOGAS, refer to the torque values in the **test certificate** provided for each individual valve serial number.

Otherwise, refer to the manufacturer's specifications.

THIS WILL AFFECT THE VALVE WARRANTY.

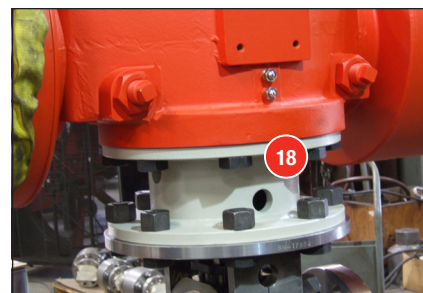

Rotate Operator

Actuator Adaption

8 VERIFY OPERATION

Note:

The MOGAS valve operates **counter-clockwise to open, clockwise to close**.

The actuator should be stroked to ensure that the ball **01A** is rotating properly, and the ball position matches the **open / closed** indicators on the actuator.

If the ball requires alignment, the actuator stops should be reset at this time, per the manufacturer's specifications.

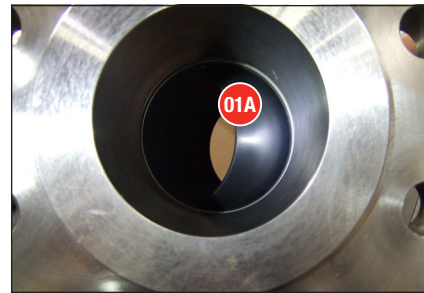

Stroke the ball to ensure proper rotation.

9 SET STOP POSITIONS

Note:

The actuator stops may be reset per the manufacturer's specifications to achieve a **fully open** and / or **fully closed** position.

The **fully open** position is the most important position to set. It is preferred that the **open** position be set **before** the valve is installed in the pipeline.

The **fully open** position should properly align the bore, ensuring that no edges of the ball **01A** are exposed to the flow.

For visual verification of **open / closed**, locate the **scribed lines** on the stem **05** and gland flange **07**. These lines are approximate locations and should not be used for setting the **open** stop. For best results, ensure the lines never under travel — a minimum travel of 96° is required.

When the actuator is properly set, the scribed lines on the stem and gland flange should match.



Fully OPEN position.

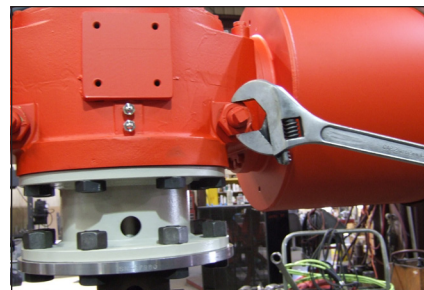

Set stop positions.



CAUTION!

Misalignment can result in valve under- or over-stroke, creating a potential leak path.

THIS WILL AFFECT THE VALVE WARRANTY.

Replace Stem Packing



CAUTION!

It is **extremely important** to follow these steps to ensure maximum valve performance.

THIS WILL AFFECT THE VALVE WARRANTY.

Note:

Mark any matching components with a marker, tape, etc., prior to disassembly, for ease of reassembly.

1 REMOVE OPERATOR

Refer to **Remove Operator – Manual Adaption (Handlever)** (page 22) or **Remove Operator – Actuator Adaption** (page 24) as required.

2 REMOVE FLANGE BUSHING

Remove the flange bushing **16** by driving it upwards and off the mounting flange **14**, using a hammer and brass or aluminum rod if necessary.

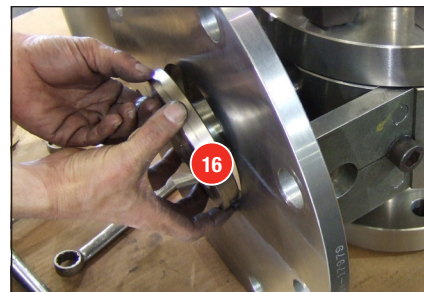

3 REMOVE GLAND NUTS

Remove the packing gland nuts **15**.

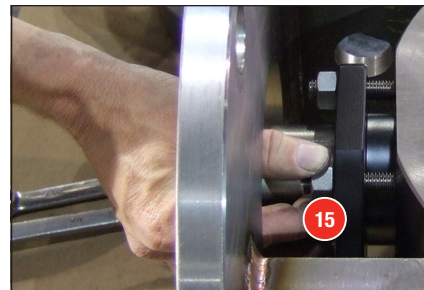

4 REMOVE GLAND FLANGE

Lift upward to remove the packing gland flange **07**.

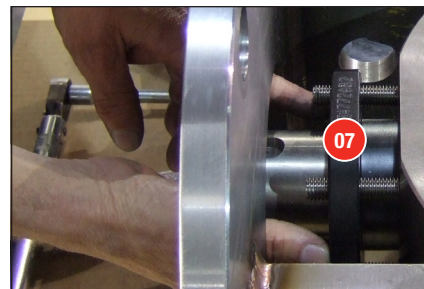

Replace Stem Packing

5 REMOVE STEM PACKING

Using a small pick or scribe, carefully remove the packing material **09A** and **09B**.

Make sure that all of the packing is removed.



CAUTION!

Do not scratch the stem or the packing bore in the body. Scratches could cause a leak.

THIS WILL AFFECT THE VALVE WARRANTY.



6 CLEAN PACKING BOX

Before installing the new packing, make sure the packing box is clean.

If needed, use an air hose to clean debris from packing box before installing new packing rings.

Note:

Always wear a face shield or goggles to protect eyes from flying debris.

7 PACKING RING SET

The new packing ring set will contain four to five rings total (two rope-like anti-extrusion rings **09B** and two to three die-form stem packing rings **09A**).

Note:

Refer to Bill of Materials supplied with each individual valve serial number for specific quantity.

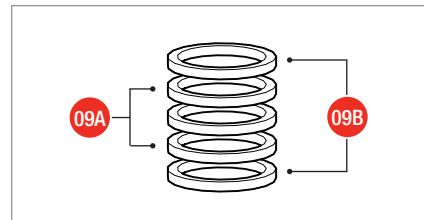

Replace Stem Packing

8 INSTALL PACKING RINGS

Note:

Applying a spray lubricant to packing ring surfaces may ease the installation process.

Install the rings one at a time (one anti-extrusion ring **09B** first, then each stem packing ring **09A** and then the second anti-extrusion ring **09B**) using the gland flange **07** as a packing tool to stuff each packing ring all the way down against the previous ring.

Make sure scribe line of stem is lined up with scribe line of packing gland.

▶ CHECK POCKET DEPTH

Before installing the second anti-extrusion ring **09B** ensure there is enough depth for the anti-extrusion ring to fit flush in the pocket.

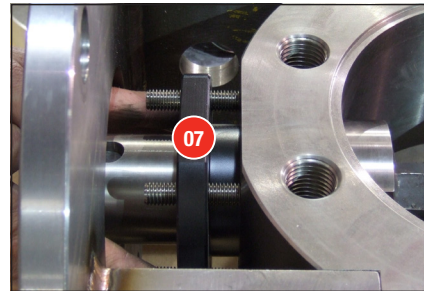
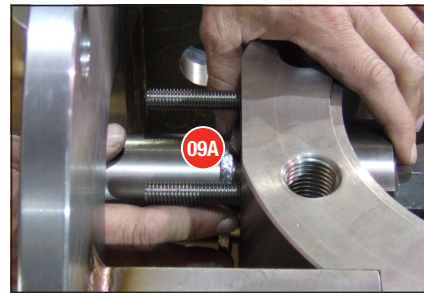

Replace Stem Packing

9 FINAL PACKING RING

If there is enough depth for the second anti-extrusion ring **09B** to fit flush in the pocket, install the anti-extrusion ring **09B**.

- ▶ If there is not enough depth for the second anti-extrusion ring **09B** to fit flush in the pocket, do not install the anti-extrusion ring **09B**.

Use the gland flange **07** to compress the packing rings enough to fit the second anti-extrusion ring **09B** flush into the pocket. Make sure scribe line of stem is lined up with scribe line of packing gland.

To do this, install the gland flange **07**.

Apply anti-seize compound onto gland studs **12** and gland nuts **15**.

Install the gland nuts **15**, tightening all nuts evenly until there is enough depth for the second anti-extrusion ring to fit flush into the pocket.

Once this is accomplished, remove the gland nuts **15** and the gland flange **07**.

Install the second anti-extrusion ring **09B**.

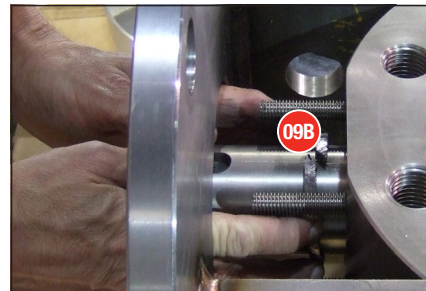
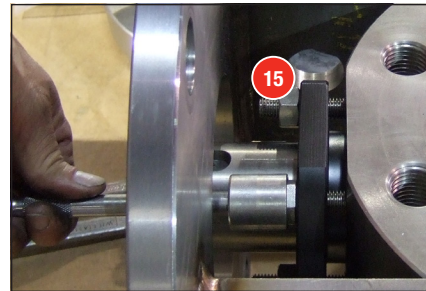
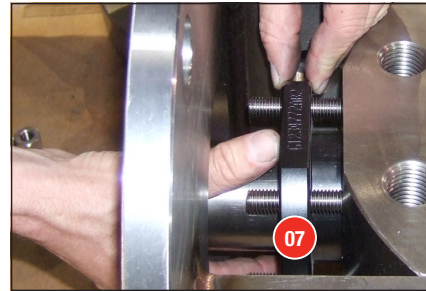

Replace Stem Packing

10 INSTALL GLAND FLANGE

Make sure gland studs **12** are in place. If necessary, install gland studs **12**, using anti-seize compound.

Install gland flange **07** over stem **05** and gland studs **12**.

Apply anti-seize compound onto gland studs **12** and gland nuts **15**.

Install gland nuts **15**, and torque all nuts **evenly** per the specifications included with the **test certificate** for each individual valve serial number.



CAUTION!

The gland flange **must** be pulled down evenly to prevent “cocking” or side loading, as this could cause damage to the packing and prevent the valve from operating properly.

Watch the gland flange to ensure that it remains **perpendicular** to the stem, and the gap around the stem remains **concentric** during the tightening process.

Do not over-tighten nuts. Torque all nuts **evenly** per the specifications included with the **test certificate** for each individual valve serial number.

THIS WILL AFFECT THE VALVE WARRANTY.

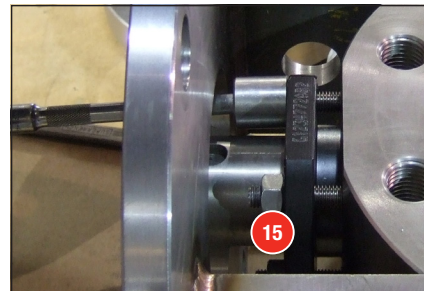
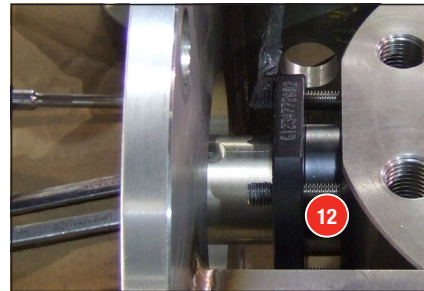
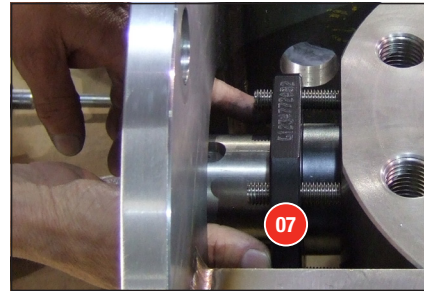

11 INSTALL FLANGE BUSHING

Insert the flange bushing **16**.

If necessary, tap into place using a hammer and a brass or aluminum rod or wooden block.



12 INSTALL OPERATOR

Refer to **Install Operator – Manual Adaption (Handlever)** (page 10) or **Install Operator – Actuator Adaption** (page 14) as required.

Disassembly



CAUTION!

If you disassemble, rework and re-assemble this ball valve, **YOU WILL VOID YOUR WARRANTY.**

Before beginning any work, identify the valve model by checking the number on the side of the valve body. To locate the model number, see page 58, **Locate Valve Information.**

Mark any matching components with a marker, tape, etc., prior to disassembly, for ease of reassembly.



CAUTION!

Verify that the ball is in the **fully closed** position prior to actuator removal and valve disassembly.

Note:

Larger valves may require that the actuator **remain installed** in order to rotate the ball position prior to the removal of valve from piping.

Larger valve / actuator combinations with limited clearance may require removal of the valve and the actuator from piping as **separate components.**

Smaller valve / actuator combinations with adequate clearance may typically be removed from piping as **one assembly.**

1 REMOVE OPERATOR

Refer to **Remove Operator** (pages 22–25) to remove manual adaption or actuator adaption as required.

2 REMOVE MOUNTING FLANGE ADAPTOR

If mounting flange adaptor **51** is present, it must be removed.

Note:

Mark any matching components with a marker, tape, etc., prior to disassembly, for ease of reassembly.

Remove nuts **24** and hexhead screws **25** holding the mounting flange adaptor **51** to the valve mounting flange.

Lift the mounting flange adaptor straight up and off the valve mounting flange.

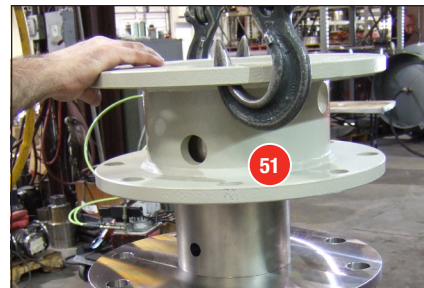

Disassembly

3 REMOVE VALVE

Remove valve from piping.

Note:

Support or lift as required.

Let valve rest on body end with bore vertical.

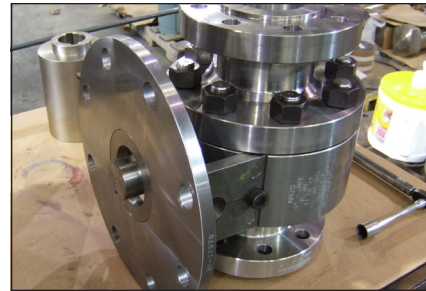

4 REMOVE BODY NUTS

Remove body nuts **11**.

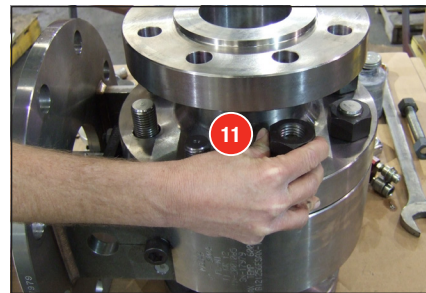

5 REMOVE END CONNECTION

Remove end connection **03**.

Note:

Mark any matching components with a marker, tape, etc., prior to disassembly, for ease of reassembly.

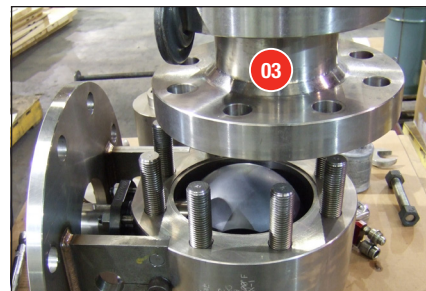

CAUTION!

Do not damage sealing surface inside body gasket counter bore.

Place end connection on a flat surface in the vertical position with flanged-end down.



If you do not have a **CA** model valve, **go to Step 8**.

Disassembly

The following steps 6 and 7 apply only to **CA** model valves. To locate the model number, see page 58, **Locate Valve Information**.

6 REMOVE SEAT LOCKING SCREWS

Remove seat locking screws **62** (if provided).

Note:

Seat locking screws have been tack-welded at factory. Remove tack-weld prior to removal of screws.

Note:

Mark any matching components with a marker, tape, etc., prior to disassembly, for ease of reassembly.



7 REMOVE SEAT LOCKING RING

Remove seat locking ring **61** from end connection **03**.



8 REMOVE SEAT RING

Remove seat ring **01B** from end connection **03**.



CAUTION!

Do not damage seat pocket.



9 REMOVE BODY STUDS

Remove body studs **10** from body **02**.



Disassembly

- 10 REMOVE BODY GASKET**
Remove body gasket **04** from body **02**.

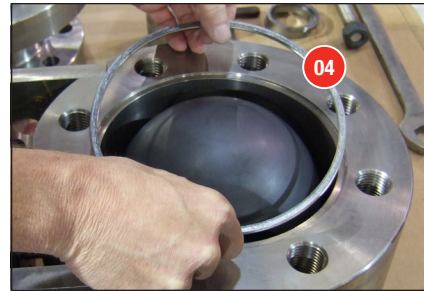

- 11 VERIFY CLOSED POSITION**
Verify that the ball **01A** has been rotated to the fully closed position.

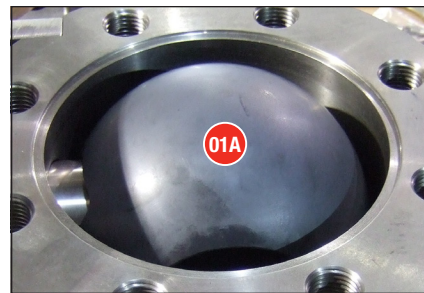

- 12 REMOVE BALL**
Remove ball by lifting the end opposite stem **05** and “rolling it out” until ball **01A** is clear of body **02**.



CAUTION!

For larger valves, use nylon straps to prevent damage to ball coating.



Disassembly

- 13 REMOVE SEAT RING**
Remove seat ring **01B** from body **02**.

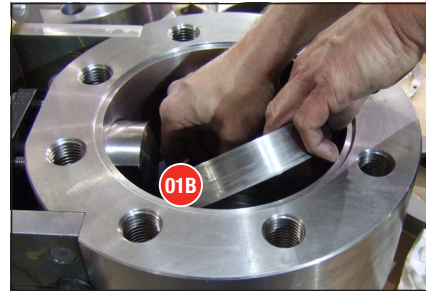

- 14 REMOVE SPRING DISC**
Remove spring disc **01C** from body **02**.



Note:
If CA-2AS valve, there will be two seat discs to remove.

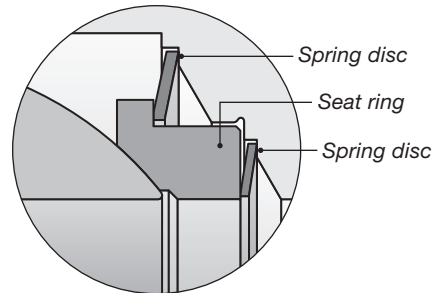

- 15 REMOVE STEM ADAPTOR**
If stem adaptor **13** is present, it must be removed.

Remove stem adaptor **13** by lifting straight up and off the stem **05**, taking care to remove keys **06** as well.

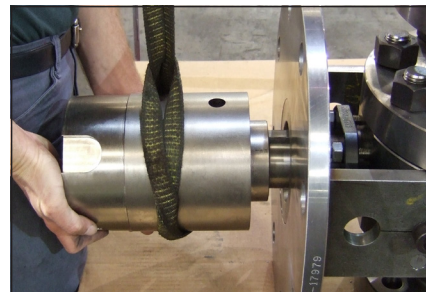

Disassembly

- 16 REMOVE FLANGE BUSHING**
Remove the flange bushing **16** by driving it upwards and off the mounting flange, using a hammer and brass rod if necessary.

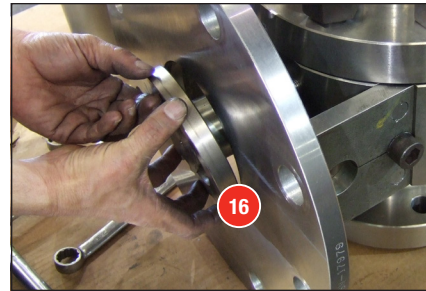

- 17 REMOVE GLAND NUTS**
Remove the packing gland nuts **15**.

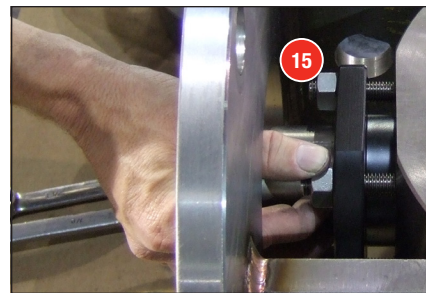

- 18 REMOVE GLAND FLANGE**
Lift upward to remove the packing gland flange **07**.

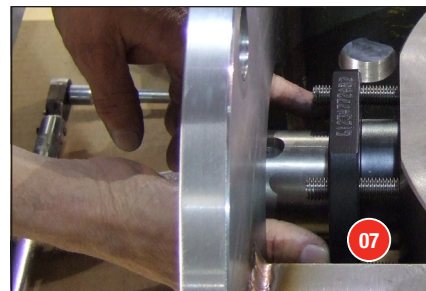

- 19 STEM ACCESS PORT**
Determine if the valve has a stem access port. If **no** access port is used, skip to the next step.
- If a stem access port **is** present, the access plate **27** must be removed.
- Remove access plate nuts **23**, access plate **27**, gasket **21** and studs **22**.

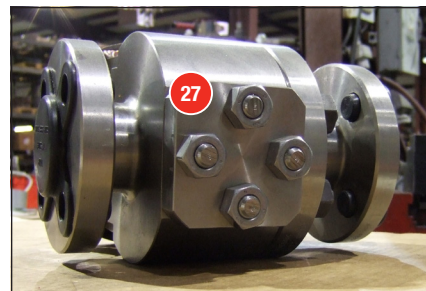

Disassembly

20 REMOVE STEM

Using a hammer and brass or aluminum rod, or wooden block, tap stem **05** into body cavity.

Carefully remove stem through access port or body cavity.

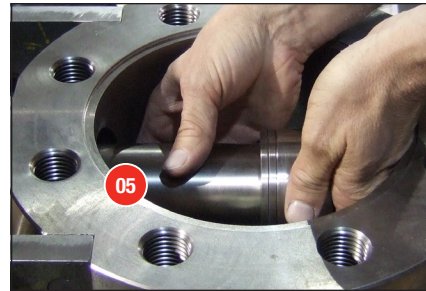

21 REMOVE STEM SEALS

Remove inner stem seals **08** from stem.



22 REMOVE STEM PACKING

Using a small pick or scribe, carefully remove the packing material **09A** and **09B**.

Make sure that all of the packing is removed.



CAUTION!

Do not scratch the stem or the packing bore in the body. Scratches could cause a leak.



23 CLEAN PACKING BOX

Before installing the new packing, make sure the packing box is clean.

If needed, use an air hose to clean debris from packing box before installing new packing rings.

Note:

Always wear a face shield or mono-goggles to protect eyes from flying debris.

Rework Components



CAUTION!

If you disassemble, rework and re-assemble this ball valve, **YOU WILL VOID YOUR WARRANTY.**

Lapping compound, lapping heads, and gaskets may be purchased from MOGAS.

1

SEAT LANDING SURFACES

Clean body and end connection seat-landing surfaces with 400 grit wet emery cloth and steel wool or Scotch-Brite®.

Inspect seat landing surfaces for damage or imperfections. If surfaces are damaged, return to MOGAS or a MOGAS authorized repair facility for repair or replacement.

If body and / or end connects are not running true and parallel (show any distortion or warpage) return it to MOGAS or a MOGAS authorized repair center.



Rework Components

2 BALL AND SEATS

If the valve model is a DRI, DRIS or 1US, this step is not required.

Notes:

IMPORTANT: The seats are uniquely identified to fit **only** a body or end connection. Seats identified with an odd number fit the body only; seats identified with an even number fit the end connection only.

Seat identification is also provided inside the stem slot of the ball to ensure correct assembly of mate-lapped components.

When installing ball and seat assembly, lightly lap back of seats **01B** to metal sealing surface on body **02** and end connections **03**, using lapping compound.

Apply machinist blue lightly to back of seat, then contact body and end connection to visually confirm full clean-up of sealing surface.

If surfaces do not clean up, send to MOGAS or a MOGAS authorized repair facility for re-machining, or call +1.281.449.0291 for technical assistance.

▶ BALL / SEAT LAPPING

Ball reworking and ball / seat lapping should **only** be performed by MOGAS or a MOGAS authorized repair facility.

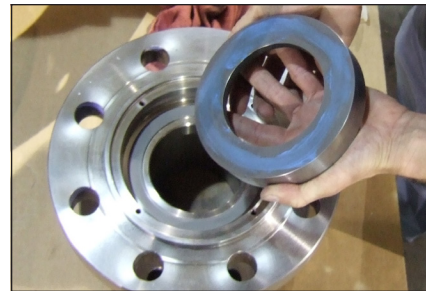
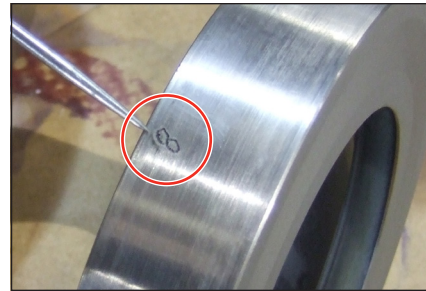

CAUTION!

Only MOGAS approved components should be used in re-assembled valves.

3 CLEAN AND INSPECT

Clean all parts thoroughly before assembly.

Inspect seats and landing surfaces to ensure full contact.



CAUTION!

Any surface imperfections may create a leak.



▶ All seals, gaskets, spring(s) and packing must be replaced with new materials during assembly, to ensure proper valve operation.

Note:

Refer to **Valve Part Reference Number** drawings (pages 4–7) for identification of all seals, gaskets, spring(s) and packing.

Re-Assembly



CAUTION!

If you disassemble, rework and re-assemble this ball valve, **YOU WILL VOID YOUR WARRANTY.**

1

CLEAN ALL PARTS

Clean all parts before assembly and / or parts replacement.



2

POSITION VALVE BODY

Prior to assembly, verify that the valve body **02** is resting on a flat surface in the vertical position with the flanged-end down and body cavity upright.



3

INSTALL PACKING GLAND STUDS

Apply anti-seize compound before installing studs **12**.

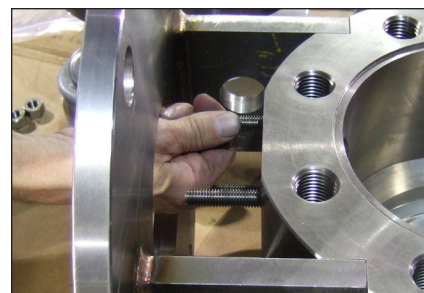

Re-Assembly

4 INSTALL STEM SEALS

Place inner stem seals **08** on stem **05**.



CAUTION!

Inner stem seals are coated on one side; the chamfer side is the uncoated side. Install with coated sides facing each other.

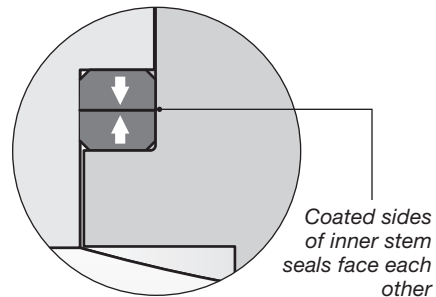

5 INSERT STEM

Insert stem **05** through body **02** cavity and through top stem bore.



STEM ACCESS PORT

Some stems will not fit through the body cavity, requiring a stem access port in the valve body for stem insertion.



6 STEM ORIENTATION

Verify that the keyway nearest the stamped **T** on the end of the valve stem **05** is oriented properly ('T' to the top).

When the valve is **closed**, the keyway nearest the stamped **T** should face the end connection **03**, or body-bolting side of valve.

When the valve is **open**, the keyway nearest the stamped **T** should be 90° counter-clockwise from the end connection **03**, or body-bolting side of the valve.

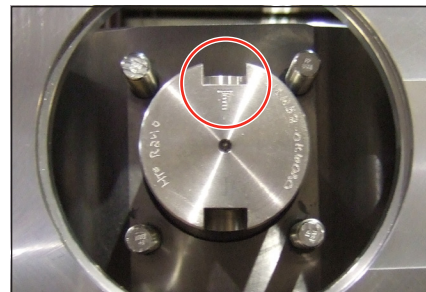

'T' to the top.

Re-Assembly

7 STABILIZE STEM

Use a jacking bolt (or similar tool) to maintain light pressure between bottom of stem and inside of valve body cavity. This prevents movement of the stem while installing packing rings.



CAUTION!

To prevent damage to inner stem seals, do not use excessive force when using jack bolt (or similar tool).

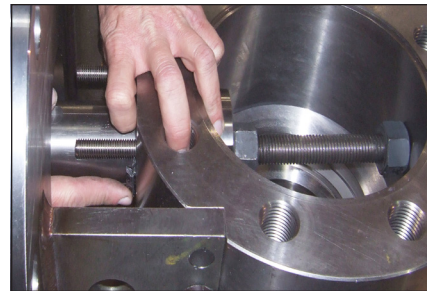
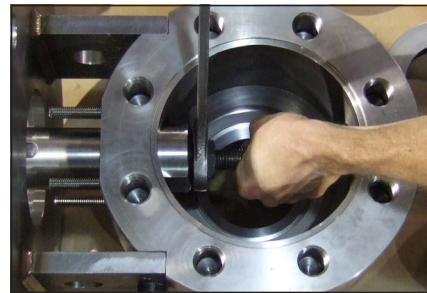

8 PACKING RING SET

The new packing ring set will contain four to five rings total (two rope-like anti-extrusion rings **09B**, two to three die-form stem packing rings **09A**).

Note:

Refer to Bill of Materials supplied with each individual valve serial number for specific quantity.

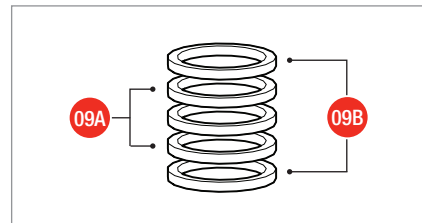

Re-Assembly

9 INSTALL PACKING RINGS

Note:

Applying a spray lubricant to packing ring surfaces may ease the installation process.

Install the rings one at a time (one anti-extrusion ring **09B** first, then each stem packing ring **09A**, followed lastly by the second anti-extrusion ring **09B**) using the gland flange **07** as a packing tool to stuff each packing ring all the way down against the previous ring.

Make sure scribe line of stem is lined up with scribe line of packing gland.

▶ CHECK POCKET DEPTH

Before installing the second anti-extrusion ring **09B** ensure there is enough depth for the anti-extrusion ring to fit flush in the pocket.

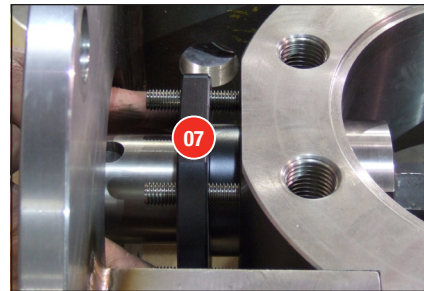
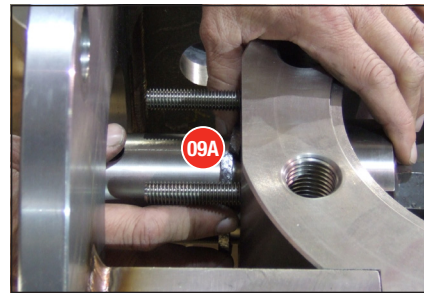

Re-Assembly

10 FINAL PACKING RING

If there is enough depth for the second anti-extrusion ring **09B** to fit flush in the pocket, install the anti-extrusion ring **09B**.

- ▶ If there is not enough depth for the second anti-extrusion ring **09B** to fit flush in the pocket, use the gland flange **07** to compress the packing rings enough to fit the second anti-extrusion ring **09B** flush into the pocket. Make sure scribe line of stem is lined up with scribe line of packing gland.

Apply anti-seize compound onto gland studs **12** and gland nuts **15**.

Install the gland nuts **15**, tightening all nuts evenly until there is enough depth for the second anti-extrusion ring to fit flush into the pocket.

Once this is accomplished, remove the gland nuts **15** and the gland flange **07**.

Install the second anti-extrusion ring **09B**.

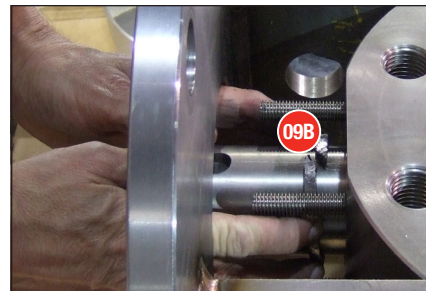
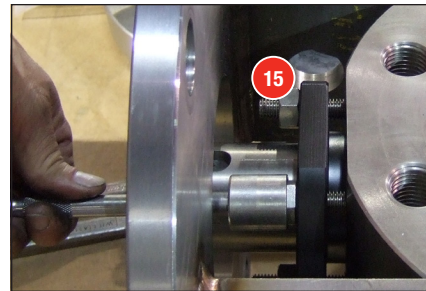
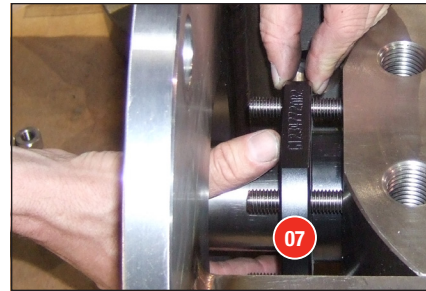

Re-Assembly

11 INSTALL GLAND FLANGE

Make sure gland studs **12** are in place. If necessary, install gland studs **12**, using anti-seize compound.

Install gland flange **07** over stem **05** and gland studs **12**.

Apply anti-seize compound onto gland studs **12** and gland nuts **15**.

Install gland nuts **15**. Torque all nuts **evenly** per the specifications included with the **test certificate** for each individual valve serial number.



CAUTION!

The gland flange **must** be pulled down evenly to prevent “cocking” or side loading, as this could cause damage to the packing and prevent the valve from operating properly.

Watch the gland flange to ensure that it remains **perpendicular** to the stem, and the gap around the stem remains **concentric** during the tightening process.

Do not over-tighten nuts. Torque all nuts **evenly** per the specifications included with the **test certificate** for each individual valve serial number.

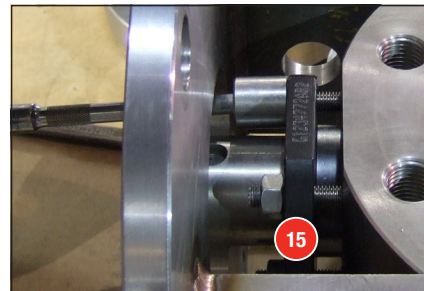
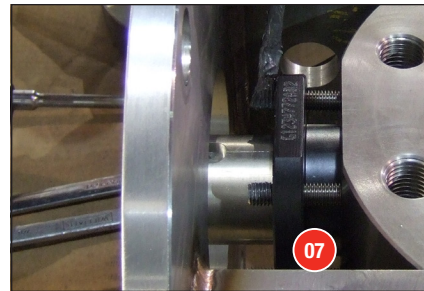
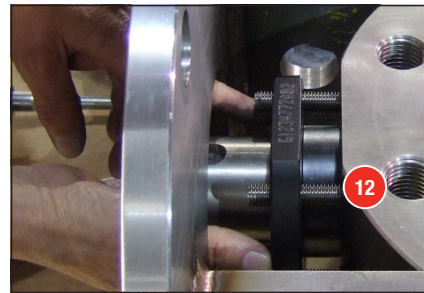

▶ If a jacking bolt (or similar tool) was used, it should now be removed.

If **no** jacking bolt (or similar tool) was used, it may be necessary to “bottom out” the stem to make contact between the stem seal bearings and the stem bore shoulders.

Using an aluminum or brass rod or a wooden block, “drive” the stem with a hammer until the contact is made. You will hear a distinct tone when contact is made.

Re-Assembly

12 STEM ACCESS PORT

Determine if the valve has a stem access port. If there is **no** stem access port on your valve, skip to the next step.

If a stem access port **is** used, the cover must be installed.

Apply anti-seize on studs **22** and install into body **02**.

Install gasket **21** and access plate **27**.

Install nuts **23**, applying anti-seize onto studs **22** and nuts **23**. Tighten nuts **23** alternately until gasket is uniformly compressed.

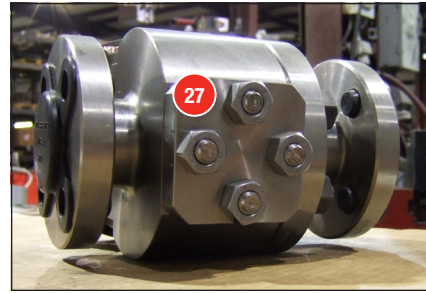

CAUTION!

Torque the access plate bolting (if applicable) per the specifications included with the **test certificate** for each individual valve serial number.

13 INSTALL THE FLANGE BUSHING

Insert the flange bushing **16**.

If necessary, tap into place using a hammer and a brass or aluminum rod or wooden block.



Re-Assembly

14 INSTALL SPRING DISC

Verify that the valve body **02** is resting on a flat surface in the vertical position with the flanged-end down.

Install spring disc **01C** in body cavity.



Note:

If CA-2AS valve, there will be two spring discs to install.

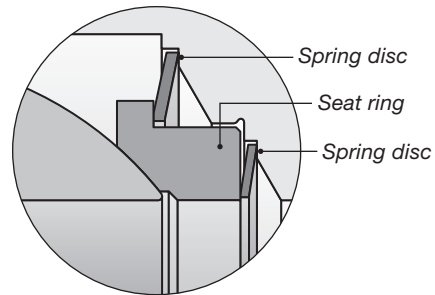

15 INSTALL SEAT RING

Install seat ring **01B** in pocket just above spring disc **01C** in body cavity.

Note:

*The seat rings are uniquely identified to fit **only** a body or end connection. Seats identified with an odd number fit the body only; seats identified with an even number fit the end connection only.*

Seat ring identification is also provided inside the stem slot of the ball to ensure correct assembly.



Re-Assembly

16 INSTALL BALL

Note:

Matching Identification: The seat rings are uniquely mate-lapped to the ball. Seats identified with an odd number fit the body only; seats identified with an even number fit the end connection only.

Seat ring identification is also provided inside the stem slot of the ball to ensure correct assembly.

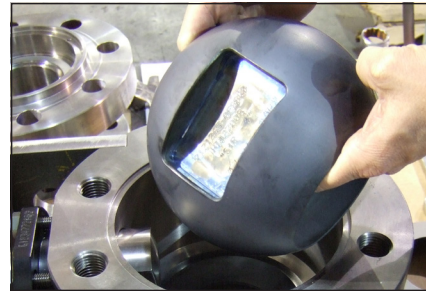

Lightly coat ball with a silicone grease.

Lower ball **01A** into body cavity over properly aligned stem **05**.

Note:

*The stamped **T** or single scribe line should be facing up, or 'T' to the top, at point of assembly.*



Roll ball **01A** into a fixed, closed position.



Ball **01A** should “rock” when properly positioned.



CAUTION!

For larger valves, use nylon straps to prevent damage to ball coating.



Re-Assembly

17 INSTALL BODY GASKET

Install body gasket **04** into groove, located at body face where end connection **03** mates to body **02**.

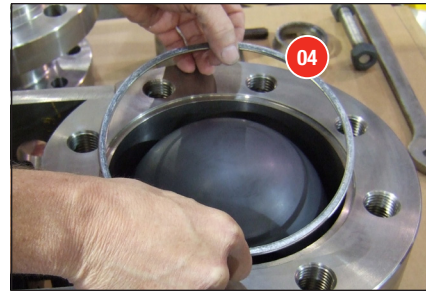

18 INSTALL BODY STUDS

Install body studs **10**, using anti-seize compound.

Temporarily cover ball to protect coating from any debris during stud installation.

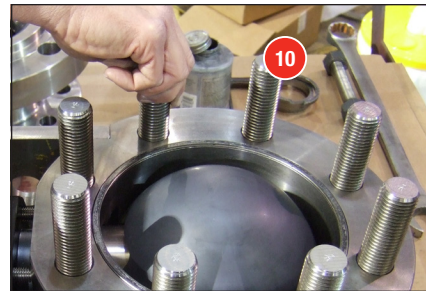

19 POSITION END CONNECTION

Prior to assembly, verify that the end connection **03** is resting on a flat surface in the vertical position with the flanged-end down and seat pocket upright.

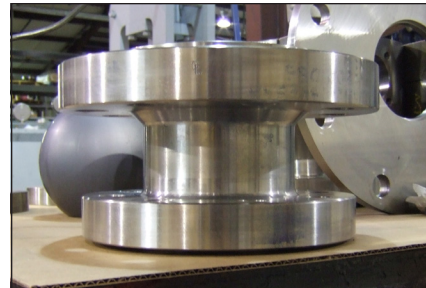

Re-Assembly

20 INSTALL SEAT RING

Install seat ring **01B** into end connection **03** seat pocket.

Note:

If you do not have a locking ring, use silicone pasted to coat the side of the seat ring that will face the end connection. Push coated side of seat ring against end connection, rotate 90° and proceed to Step 23. This will keep the seat ring properly in place when the end connection is installed.

Note:

The seat rings are uniquely identified to fit **only** a body or end connection. Seats identified with an odd number fit the body only; seats identified with an even number fit the end connection only.

Seat ring identification is also provided inside the stem slot of the ball to ensure correct assembly.



Steps 21 and 22 below apply to **CA** model valves. If you do not have a **CA** model valve, **go to Step 23**.

21 INSTALL SEAT LOCKING RING

Place seat locking ring **61** in position above seat ring **01B**.



22 INSTALL SEAT LOCKING SCREWS

Install seat locking screws **62** (if provided) to secure the seat ring **61** in place.

Tighten the seat locking screws **62** by hand to prevent distorting the seat locking ring **61**.

Once seat locking screws **62** are tight, **tack-weld** in position to prevent movement during operation.



CAUTION!

Cover seat ring to protect it from weld spatter.

Re-Assembly

23 INSTALL AND SECURE END CONNECTION

Carefully invert end connection **03**.

Install end connection **03** assembly onto body **02** by positioning it (seat facing down) over body bore. Align bolt holes with studs and align bolt pattern of end flanges as well as match marks made during disassembly.

Note:

MOGAS valve flanges are supplied in the customary "straddle centerline" hole orientation, unless otherwise specified.

Lower end connection onto body face. Watch that seat ring does not fall out or crush body gasket.

Apply anti-seize compound on body studs **10** and nuts **11**.

Install nuts **11**, alternately tightening all nuts.

Do not torque bolting at this time.

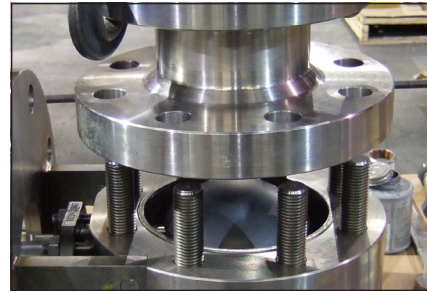

24 VERIFY OPERATION

The valve should be stroked one full cycle to ensure that the ball **01A** is rotating properly.

If valve does not stroke smoothly, disassemble and take corrective action.

Note:

Larger valves may require the actuator to be in place to rotate the ball.

Re-Assembly

25 TORQUE BODY BOLTING

Torque the valve body bolting to secure the body **02** and end connection **03** assembly.



CAUTION!

Torque the valve body bolting per the specifications included with the **test certificate** for each individual valve serial number.

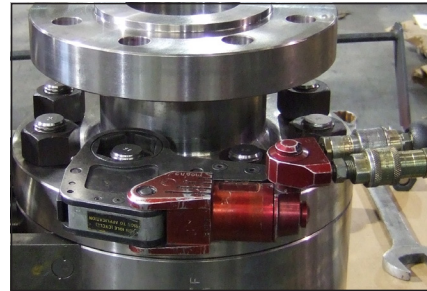

26 INSTALL OPERATOR

Install the operator as required for manual adaption or actuator adaption.

Refer to **Install Operator** section (page 10 for manual adaption, page 14 for actuator adaption).

27 FIELD HYDROSTATIC TEST

Refer to MOGAS test certificate for pressures or allowable leak rates.

28 INSTALL VALVE

Install valve in piping as required.

Refer to **Installation** (page 18).

Locate Valve Information

- ▶ Valve information is provided on the body in the locations shown.

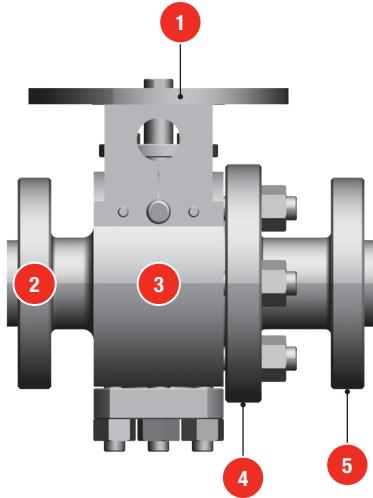

- ▶ Additional information may also be provided on identification tags per customer request.

1 VALVE SERIAL NUMBER

2 SIZE
PRESSURE CLASS
PRESSURE END
IDENTIFICATION

3 MANUFACTURER
SIZE
PRESSURE CLASS
MODEL
MATERIAL
HEAT NUMBER
SERIAL NUMBER
MAX. TEMPERATURE
BODY PART NUMBER

4 END CONNECTION
PART NUMBER
MATERIAL
HEAT NUMBER

5 SIZE
PRESSURE CLASS

Return Merchandise Authorizations (RMA)

All valve or valve parts that are **returned** require a Return Merchandise Authorization (RMA). Please have the following information available prior to submitting an RMA request:

- Serial number
- Valve owner
- Application specifics (where the valve is used)
- Media (what goes through the valve)
- Total estimated cycles (from last installation)
- Operating temperature (max. F)
- Operating pressure (max. PSI)
- Actuator specifics

Contact the MOGAS Service department to obtain authorization and to receive shipping instructions. The RMA request may also be submitted online by accessing the **Service** page of our website (www.mogas.com).

Service Contact

MOGAS Service may be reached
24 hours per day / 7 days per week.

Telephone: **+1 281.449.0291**

Email: **service@mogas.com**

Severe Service

The MOGAS Definition

- High temperature — up to 1652 F / 900 C
- High pressure — up to 43,000 psig / 2965 bar(g)
- Corrosive applications
- Abrasive particulates
- Acidic products
- Lethal media
- Heavy solids build-up
- Viscous sludge
- Critical plant safety applications

MOGAS INDUSTRIES, INC.

Headquarters

14330 East Hardy Street
Houston, TX, USA 77039-1405

Phone: +1.281.449.0291
Fax: +1.281.590.3412
E-mail: mogas@mogas.com

AUSTRALIA

Phone: +61 (0)8.9456.3533

CANADA

Phone: +1 780.436.4485

CHINA

Phone: +86 (0)10.8454.9478

EUROPE

Phone: +44 (0)1162.793367

To locate a sales and
service center in your
area, visit us online at
www.mogas.com.

MOGAS[®]
SEVERE SERVICE BALL VALVES